



ATD-8524 5 Gallon Parts Washer Owner's Manual



Features:

- Flexible spigot
- Seamless and round corner construction
- cUL approved 110V AC pump with 264 gal./hr. no load output
- Tank Capacity: 5 gallons
- 3.5 gal. maximum aqueous (water) based solvent required
- 2 gal. minimum aqueous (water) based solvent required
- Dimensions: 18" L x 13-3/8" W x 8-7/8" H

**For use with non-corrosive, aqueous (water) based solvents ONLY.
Petroleum based solvents will damage the pump and void the warranty.**

California Prop 65 WARNING:

This product contains chemicals including lead, known to the State of California to cause cancer, birth defects, or other reproductive harm. **Wash hands after handling.**

General Safety Warnings:

 **WARNING:** The instructions and warnings contained in this manual should be read and understood before using or operating this parts washer. Do not allow anyone to use or operate this tool until they have read this manual and have developed a thorough understanding of how this unit works. Failure to observe any of the following instructions could result in severe personal injury to tool user and bystanders, or cause damage to the unit and property. Keep this manual for future reference.

 **Note:** The warnings and cautions discussed in this instruction manual cannot cover all possible conditions and situations that may occur. It must be understood by the operator that common sense and caution are factors which cannot be built into this product, but must be supplied by the operator.

 **WARNING:** Use safety equipment. Users and bystanders should use safety goggles or safety glasses with side shields which comply with current national standards, or when needed, a face shield. Use an ANSI approved dust mask or respirator when working around metal, wood, and chemical dusts and mists. This applies to all persons in the work area. Also use non-skid safety shoes, hardhat, gloves, dust collection systems, and hearing protection when appropriate.

 **WARNING:** Keep bystanders and children out of the work area while operating this parts washer.

 **WARNING:** Always keep your work area clean, uncluttered, and well lit. Cluttered or dark areas invite accidents and injuries. DO NOT work on floor surfaces that are slippery.

 **WARNING:** Do not operate this parts washer if you are tired or under the influence of alcohol, drugs, or medications that could affect your ability to use the parts washer properly.

 **WARNING:** Dress properly. Do not wear loose clothing or jewelry as they can be caught in moving parts. Wear restrictive hair covering to contain long hair.

 **WARNING:** Do not reach over or across running machines. Keep proper footing and balance at all times. Non-skid footwear is recommended when working.

Electrical Safety Warnings:

 **WARNING:** Read all safety warnings and instructions. Failure to follow all warnings and instructions may result in electric shock, fire and/or serious injury or death.

 **WARNING:** Before connecting this unit to a power supply, always check to ensure the power supply corresponds to the voltage needed for this parts washer. A power supply with a voltage greater than that specified for the tool can result in serious injury to the user, as well as damage to the tool. Using a power supply with a voltage less than the specified rating is harmful to the motor. If in doubt, do not plug in the parts washer.

 **WARNING:** Grounded tools must be plugged into an outlet properly installed and grounded in accordance with all codes and ordinances. This tool is equipped with a 3-prong plug and a 3-wire grounding system. Never remove the grounding prong or modify the plug in any way. Do not use any adapter plugs. Check with a qualified electrician if you are in doubt as to whether the outlet is properly grounded.

 **NOTE:** Double insulated tools are equipped with a polarized plug (one blade is wider than the other). This plug will fit in a polarized outlet only one way. If the plug does not fit fully in the outlet, reverse the plug. If it still doesn't fit, contact a qualified electrician to install a polarized outlet. Do not change the plug in any way.

 **WARNING:** To reduce the risk of electric shock, DO NOT use in damp conditions, on wet surfaces, or expose to rain. Do not plug in this unit or operate it with wet hands or while standing in water.

 **WARNING:** Never use the cord for carrying, pulling or unplugging the power tool. Grasp plug and pull to disconnect from outlet. Keep cord away from heat, oil, sharp edges or moving parts. Replace damaged cords immediately.

 **WARNING:** Ensure the switch is in the off position before plugging the parts washer into the power outlet. In the event of a power failure while a tool is being used, turn the switch off to prevent surprise starting when the power is restored.

 **WARNING:** Always remove the power cord from the electric outlet when making adjustments, changing parts, cleaning or working on the parts washer.

 **WARNING:** Care should be taken to arrange the cord so it will not be stepped on, tripped over, or otherwise subjected to damage or stress.

 **WARNING:** Never attempt to plug in or operate equipment with defective or damaged wires, power cord or power cord plug. Have any defective or damaged parts replaced immediately by qualified personnel.

 **WARNING:** Avoid body contact with electrically grounded surfaces. There is an increased risk of electric shock if your body is grounded.

 **WARNING:** If the work area is not equipped with a permanently installed Ground Fault Circuit Interrupter outlet (GFCI), use a plug-in GFCI between the power tool or extension cord and the power receptacle.

 **WARNING:** If an extension cord is necessary, use only 'Listed' extension cords. If used outdoors, they must be marked "For Outdoor Use". Those cords having a 3-prong grounding type plugs and mating receptacles are to be used with grounded tools.

 **WARNING:** Use of improper size or gauge of extension cord may cause unsafe or inefficient operation of your unit, or cause damage to your unit. Be sure your extension cord is rated to allow sufficient current flow to the motor. If in doubt, always use a larger gauge cord. Be sure to check the voltage requirements of the tool to your incoming power source.



NOTE: The table below shows the correct size to use according to cord length and the amperage draw of the unit (specified on the washer pump). When in doubt, use the next heavier gauge. The smaller the gauge number, the heavier the cord. (AWG = American Wire Gauge).

Minimum Gauge for Extension Cords (AWG)
(when using 120 volts only)

Ampere Rating		Total Length of Cord in Feet (meters)			
More Than	Not More Than	25' (7.6m)	50' (15m)	100' (30.4m)	150' (45.7m)
0	6	18	16	16	14
6	10	18	16	14	12
10	12	16	16	14	12
12	16	14	12	Not Recommended	

Specific Safety Warnings:

- Read all instructions before using this unit.
- For use with non-corrosive, aqueous (water) based solvents ONLY. Petroleum based solvents will damage the pump and void the warranty.

-  **WARNING:** Do not fill parts washer above the shelf.
- Care must be taken as burns can occur from touching hot parts.
- Do not operate your parts washer with damaged parts. Repair your parts washer with only ATD repair parts. Any modifications to this parts washer, or use of non-ATD parts will void the warranty and could result in injury.
- To reduce the risk of fire, do not operate your parts washer in the vicinity of open containers of flammable liquids such as gasoline.
- Adequate ventilation should be provided when using your parts washer.

Technical Specifications:

Model	ATD-8524
Overall Dimensions	18" L x 13-3/8" W x 8-7/8" H
Max Solvent Capacity	3.5 Gallons
Max Pump Output	264 gal/hour no load output
Pump Voltage	110/120VAC - 60Hz
Pump Amperage	.23 Amps
Gross Weight	17 lbs.

ATD®

ATD-8524

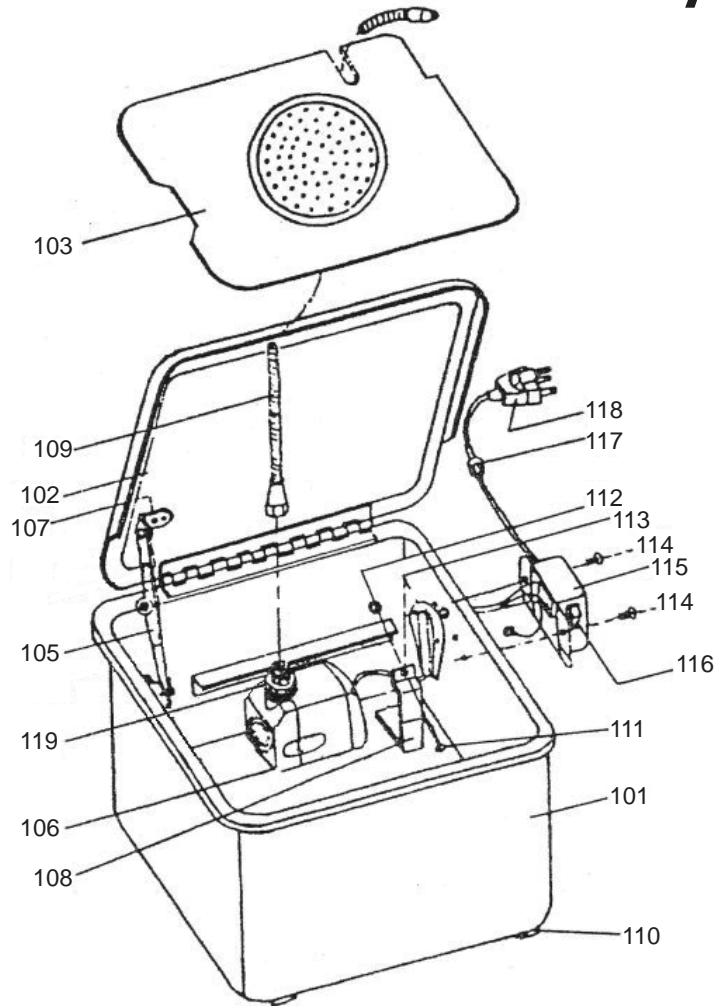

ITEM#	ORDERING PART#	PART DESCRIPTION
101	PRT8524-101	TANK
102	PRT8524-102	LID
103	PRT8524-103	HD REMOVEABLE WORK SHELF
105	PRT8524-105	SAFETY PLATE (2 PCS)
106	PRT8524-106	PUMP
107	PRT8524-107	RIVET (5 PCS)
108	PRT8524-108	PUMP HOLDER
109	PRT8524-109	FLEXIBLE METAL SPIGOT
110	PRT8524-110	PLASTIC PLATE (4 PCS)
111	PRT8524-111	SCREW, M5x30
112	PRT8524-112	NUT, M5
113	PRT8524-113	COVER
114	PRT8524-114	SCREW, M4x12 (3 PCS)
115	PRT8524-115	SWITCH COVER
116	PRT8524-116	SWITCH
117	PRT8524-117	STRAIN RELIEF
118	PRT8524-118	POWER CORD
119	PRT8525-28	SPIGOT